



ONEFLOR Installation Instructions ECO 30/55/70 Dryback LVT

The **ONEFLOR DRYBACK LVT** is a **high-quality**, resilient design flooring in various formats and designs. For more information, please refer to the technical specifications in our product collections. Below we would like to inform you about the special requirements for a successful installation of **ONEFLOR DRYBACK LVT**.

IMPORTANT GENERAL INFORMATION:

Before processing, make sure that the delivered goods are in perfect condition. Goods that have been cut to size or laid are not subject to complaint. Before installation, the goods must be checked for colour and batch uniformity. Only install planks/tiles of the same batch in one room. The relevant national standards, guidelines and regulations, together with the technical documents and generally acknowledged rules of the trade, apply when installing the ONEFLOR DRYBACK LVT. Slight differences in colour, gloss level and structure are production-related and are not a reason for complaint. Mix material when laying from 3 packages.

SUBSTRATE CONDITION:

The substrate must be leveled, load-bearing and permanently dry maximum RH 75%. The maximum height tolerance must not exceed 2-3mm per linear meter or 1mm per 10cm for tile edges. Textile floor coverings and needle fleece must be removed.

SUBFLOOR CONDITION:

Prepare the subfloor in accordance to the DIN 18365/18531-35.

The substrate must be even, load bearing, dust-free and permanently dry.

The maximum height tolerance according to DIN 18202 «Tolerances in building construction – Table 3, line 4» may not exceed 2-3 mm per linear meter and must not be exceeded.

Larger height differences must be levelled out by levelling the floor over the entire surface.

In order to level out unevenness and to obtain a uniformly absorbent substrate, the

A suitable levelling compound in a sufficient layer thickness is recommended. Please observe the instructions of the building material suppliers.

Notice : The flooring installer must check the subfloor's readiness for installation before installing the flooring and raise any concerns. Especially in case of:

- larger unevenness
- insufficiently dry subfloor.
- insufficiently firm, too porous, and too rough surface of the subfloor,
- contaminated surface of the substrate, e.g. by oil, wax, varnish, paint residues,
- incorrect height of the surface of the substrate in relation to the height of adjacent components,
- unsuitable temperature of the substrate,
- unsuitable room climate,
- missing heating protocol in case of heated floor constructions,
- missing protrusion of the edge insulation strip,
- missing marking of measuring points in case of heated floor constructions,
- missing joint plan.

When installing ONEFLOR DRYBACK LVT on underfloor heating systems, EN 1264-2 (warm water underfloor heating systems and components) must be taken into account. The surface temperature must not exceed 27°C on a permanent basis. If other underfloor heating systems are used, please consult the application engineering department of ONEFLOR-EUROPE. To prevent rot damage to wood-based subfloor constructions (e.g. wooden joists), ensure or guarantee sufficient rear ventilation of the construction.

TOOLS FOR LAYING:

- Utility Knife
- Pressure roller (at least 50 kg)
- Folding rule / tape measure
- Hand pressure roller.
- White rubber mallet
- Spacer / chalk string
- Pencil / scribe
- Angle / spirit level 2m

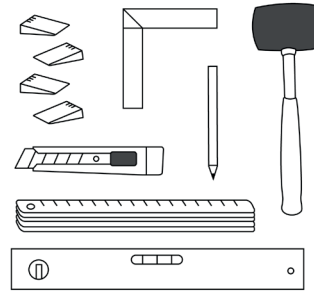

SQUARE ACCLIMATIZATION:

ONEFLOR DRYBACK LVT as well as all required auxiliary materials must be acclimatized at least 48 hours before installation in small stacks (max.3) in the rooms to be installed or adjacent rooms under the following conditions!

Room climatic conditions before, during and after laying:

- Room air temperature > 18°C (but not more than 26°C).
- Floor temperature > 15°C (but not more than 22°C)
- Relative humidity < 65%

It must be ensured that constant room climatic conditions exist during the acclimatization as well as the setting phase of the adhesive. The above-mentioned room climate must be maintained for at least 72 hours before, during and after bonding of the covering

The removal of old floor coverings is recommended to counteract interactions and irritations. The use of unsuitable underlays may lead to exclusion of warranty in case of damage

Installation

- 48h
18-25°C
64-77°F
>40%
<65%
-
-
-
- AE = 0,5% CM CT = 2,0% CM
AE = Anhydrite / CT = Cement
- AE = 0,3% CM CT = 1,8% CM
AE = Anhydrite / CT = Cement
- max. 2-3 mm per meter
- >5 mm
>2 mm

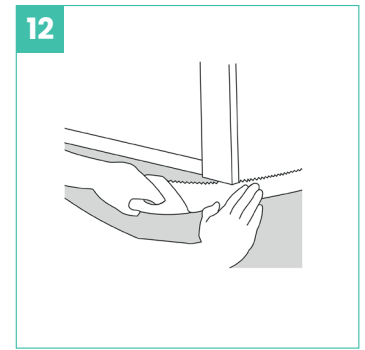
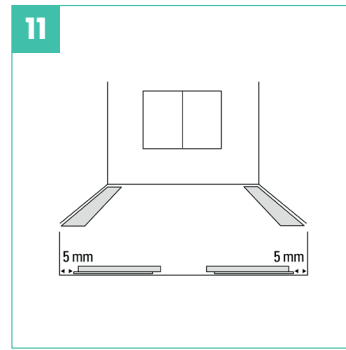
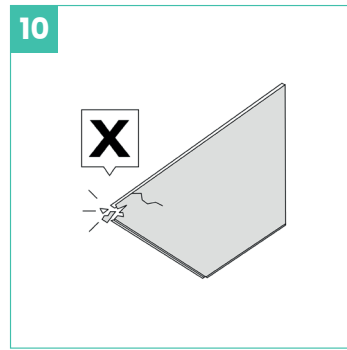
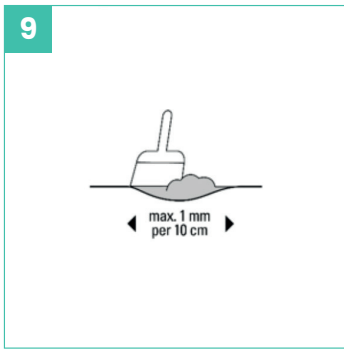

INSTALLATION

In order to achieve an ideal installation result with as little material waste as possible, we recommend measuring the corresponding surface and arranging the material format and laying pattern accordingly.

Ensure you have an appropriate joint offset (approx. 30 cm for plank formats) in order to achieve a visually appealing laying pattern.

ONEFLOR DRYBACK LVT should always be fully glued. We recommend using low-emission and solvent-free dispersion adhesives such as EC1 or RAL (Blue Angel certified). For more details, please see our adhesive recommendations. Wet-bed adhesives are preferable to regular adhesives.

The application amount can vary depending on the type of adhesive and composition, and is specified by the adhesive manufacturer or indicated on the serrated finishing spatula. For possible deviations, please see manufacturer specifications and instructions.

You must observe the processing guidelines of the adhesive manufacturer.

Note: In order to achieve an ideal installation and usage result, ensure you have applied sufficient adhesive. Do not use more adhesive than necessary in order to prevent the adhesive from seeping out. If necessary, an adhesive test can be helpful. The use of dry adhesives (see adhesive recommendation) is also possible under consideration of the manufacturer specifications and instructions.

Always lay all the planks in the same direction marked with arrows on the reverse side. The individual planks must be glued tightly and without tension and then pressed against the semi-wet adhesive bed with a suitable rubbing device. A hand roller is recommended here.

After gluing, the floor covering should also be rolled out evenly with a heavy roller (at least 50 kg). The installed area should not be used or subjected to loads until the adhesive is fully set (follow the adhesive manufacturer's specifications).

If a stage of the work is complete but has not yet been accepted, please note that the contractor is subject to a duty of maintenance (protecting the floor covering against damage during subsequent stages of work).

If the stage of work has been partially accepted, the duty of maintenance for those areas that have been accepted transfers to the customer.

You can obtain the adhesive recommendations, further information or instructions for individual installations upon request via info@oneflor-europe.com

Building expansion joints must be taken over.

Special features and exceptional situations

- Our ONFLOR design flooring meets the highest quality requirements in many respects. This also applies to the light fastness according to EN 105- B02. However, a standard test can never simulate the intensity of natural UV light, so partial color changes or fading may occur in areas with intense UV light incidence and without sufficient shading.

- A sufficiently dimensioned «radiation barrier» (e.g. glass or metal base plates) must be provided at fireplaces and tiled stoves. The size varies depending on the heating capacity of the fireplace or tiled stove. Please observe the specifications of your stove builder / chimney sweep here.

- In the case of furnishings with high static pressure loads, sufficient load distribution (e.g. load distribution plates) must be provided in accordance with the weight.

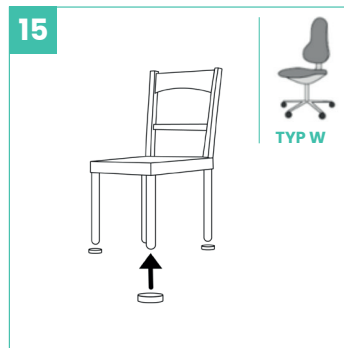
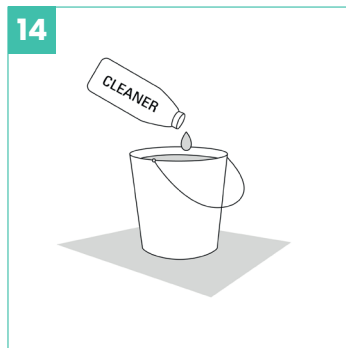
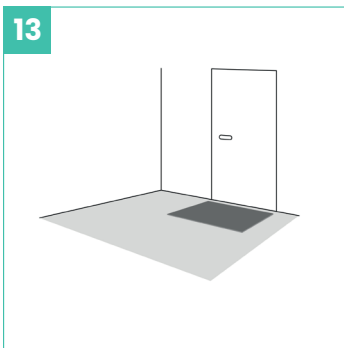

CLEANING AND CARE:

Please refer to our detailed cleaning and cleaning agent recommendations at www.oneflor-europe.com

With the publication of these installation instructions (as of 12/2021), all previous versions lose their validity.